

3D Shape Colouring

Use the key to colour in the 3D shapes correctly.

Key		
Clues	Name	Colour
no vertices, one curved surface and 2 flat circular faces		yellow
8 vertices, 12 edges the same length, 6 faces		orange
5 faces in total (4 faces are triangles and 1 is a square)		green
one apex, one circular face		red
8 vertices, 12 edges, 6 faces (2 square, 4 rectangular)		purple
no edges, no vertices and one curved surface		blue

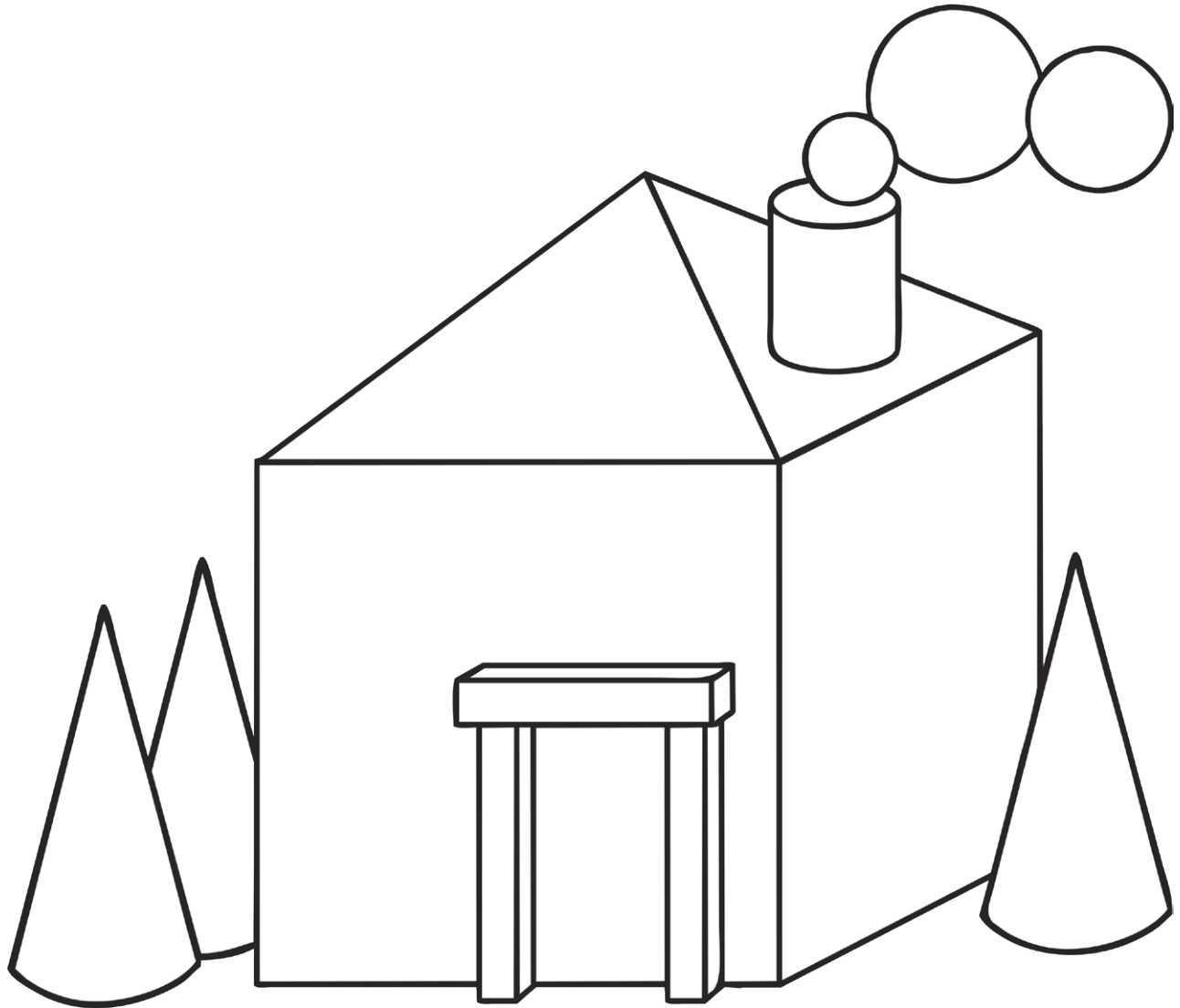

3D Shape Colouring

Use the key to colour in the 3D shapes correctly.

Key		
Clues	Name	Colour
no vertices, one curved surface and 2 flat circular faces		yellow
8 vertices, 12 edges the same length, 6 faces		orange
5 faces in total (4 faces are triangles and 1 is a square)		green
one apex, one circular face		red
8 vertices, 12 edges, 6 faces (2 square, 4 rectangular)		purple
no edges, no vertices and one curved surface		blue

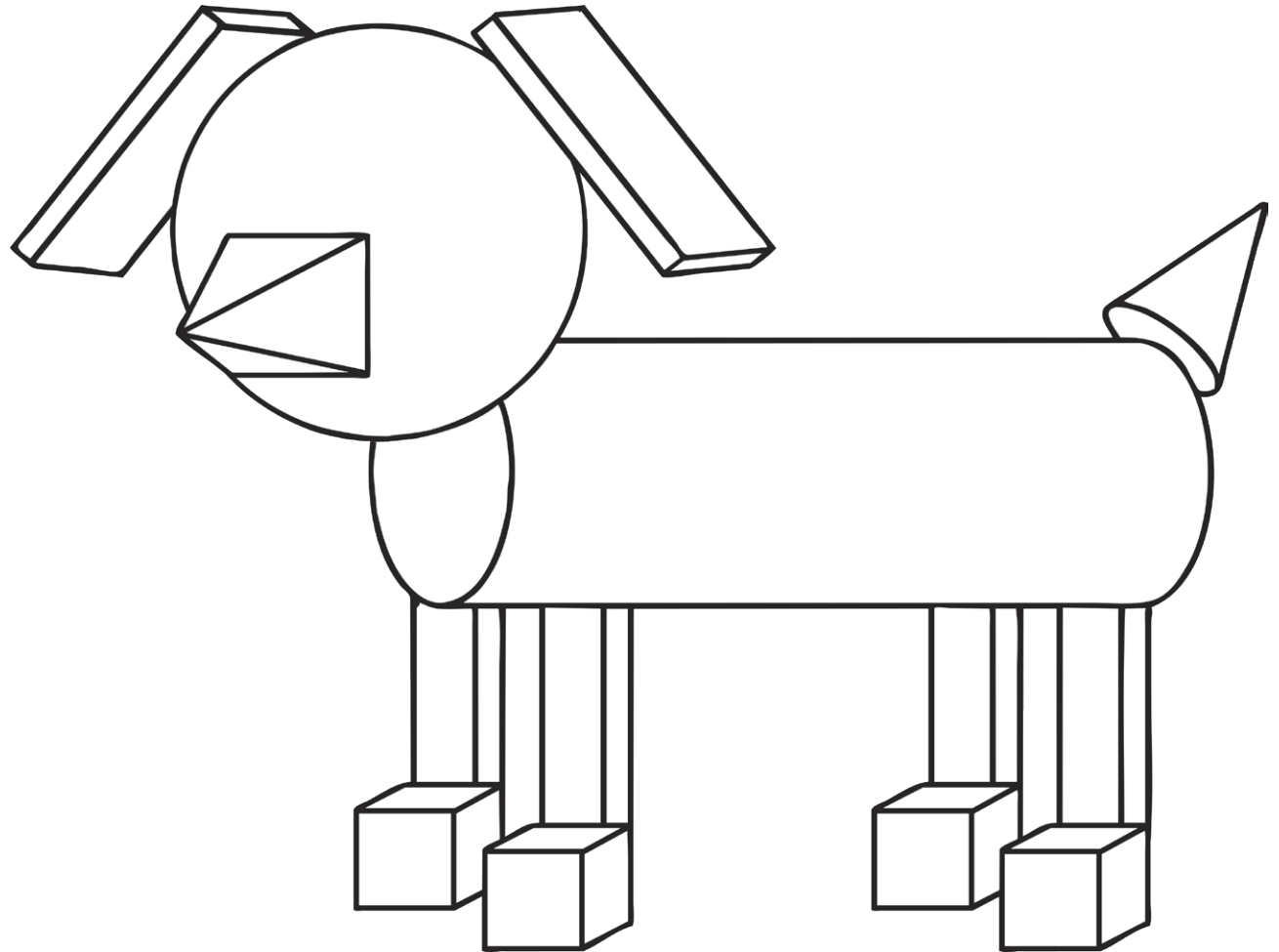

3D Shape Colouring

Use the key to colour in the 3D shapes correctly.

Key		
Clues	Name	Colour
no vertices, one curved surface and 2 flat circular faces		yellow
8 vertices, 12 edges the same length, 6 faces		orange
5 faces in total (4 faces are triangles and 1 is a square)		green
one apex, one circular face		red
8 vertices, 12 edges, 6 faces (2 square, 4 rectangular)		purple
no edges, no vertices and one curved surface		blue

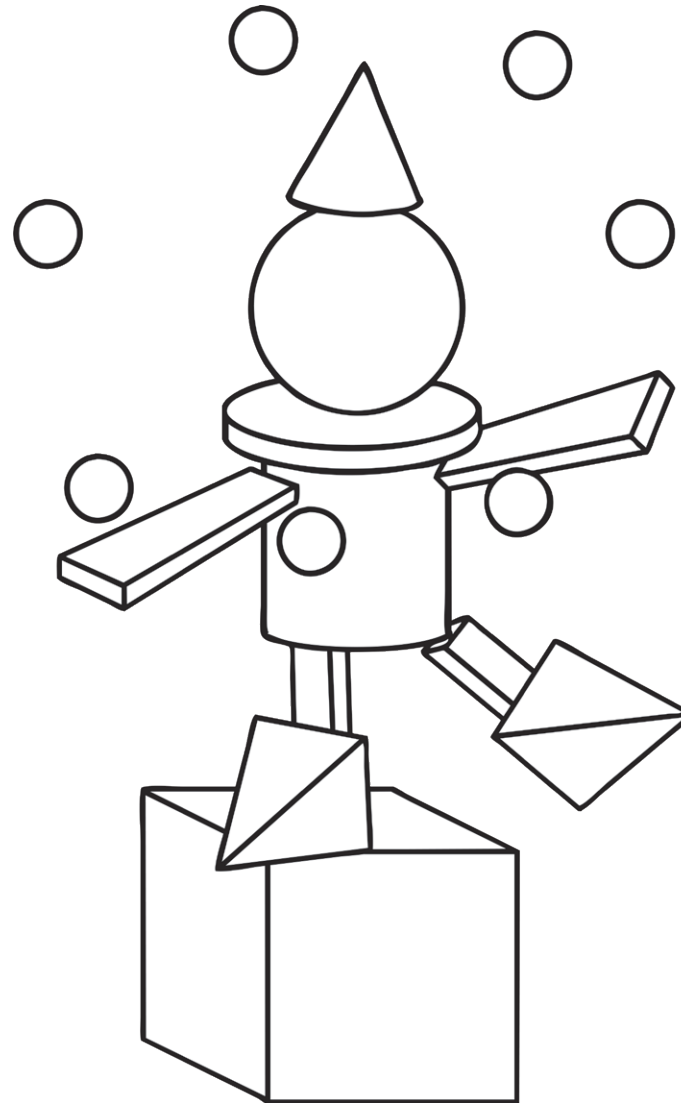

3D Shape Colouring

Use the key to colour in the 3D shapes correctly.

Key		
Clues	Name	Colour
no vertices, one curved surface and 2 flat circular faces		yellow
8 vertices, 12 edges the same length, 6 faces		orange
5 faces in total (4 faces are triangles and 1 is a square)		green
one apex, one circular face		red
8 vertices, 12 edges, 6 faces (2 square, 4 rectangular)		purple
no edges, no vertices and one curved surface		blue

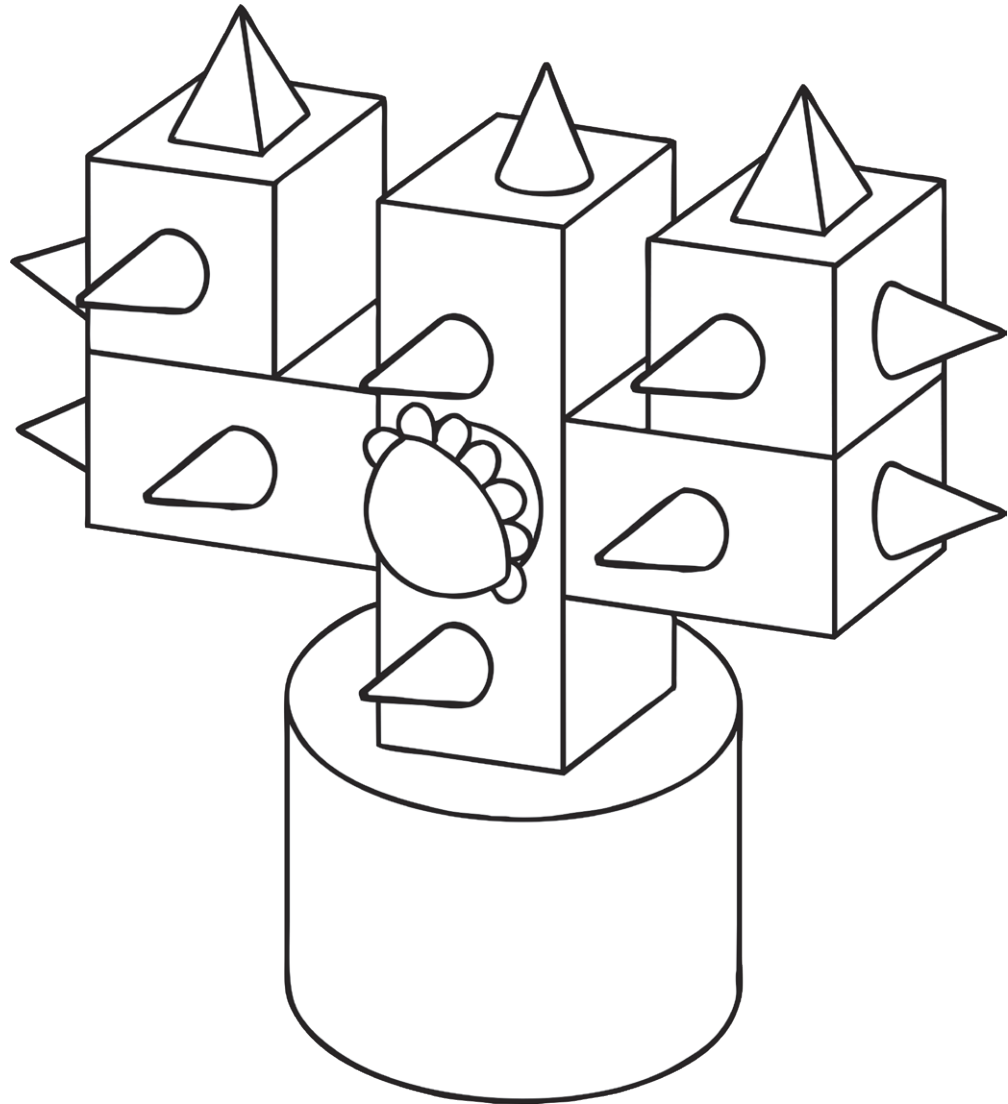

3D Shape Colouring

Use the key to colour in the 3D shapes correctly.

Key		
Clues	Name	Colour
no vertices, one curved surface and 2 flat circular faces		yellow
8 vertices, 12 edges the same length, 6 faces		orange
5 faces in total (4 faces are triangles and 1 is a square)		green
one apex, one circular face		red
8 vertices, 12 edges, 6 faces (2 square, 4 rectangular)		purple
no edges, no vertices and one curved surface		blue

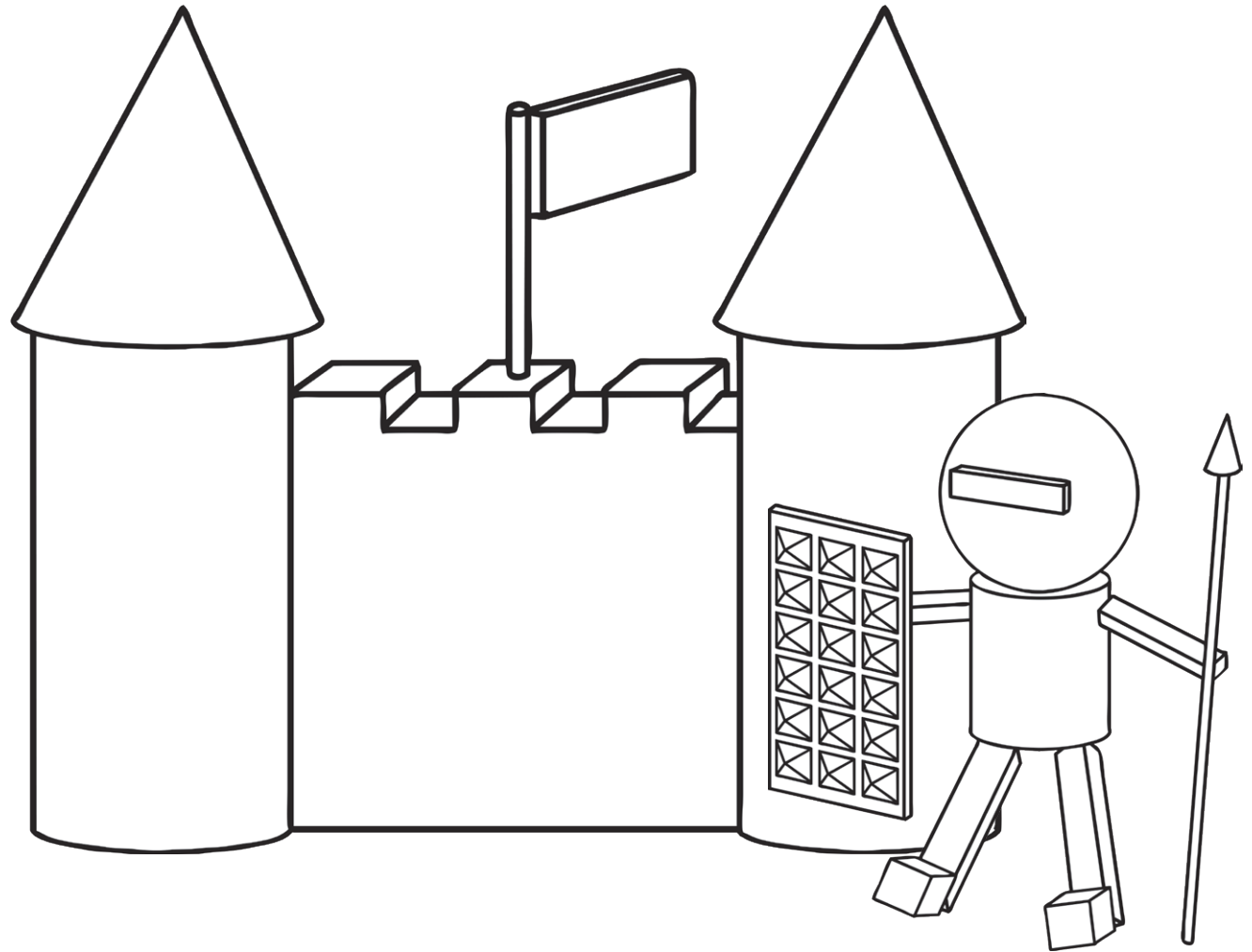

3D Shape Colouring **Answers**

Use the key to colour in the 3D shapes correctly.

Key		
Clues	Name	Colour
no vertices, one curved surface and 2 flat circular faces	cylinder	yellow
8 vertices, 12 edges the same length, 6 faces	cube	orange
5 faces in total (4 faces are triangles and 1 is a square)	square-based pyramid	green
one apex, one circular face	cone	red
8 vertices, 12 edges, 6 faces (2 square, 4 rectangular)	cuboid	purple
no edges, no vertices and one curved surface	sphere	blue

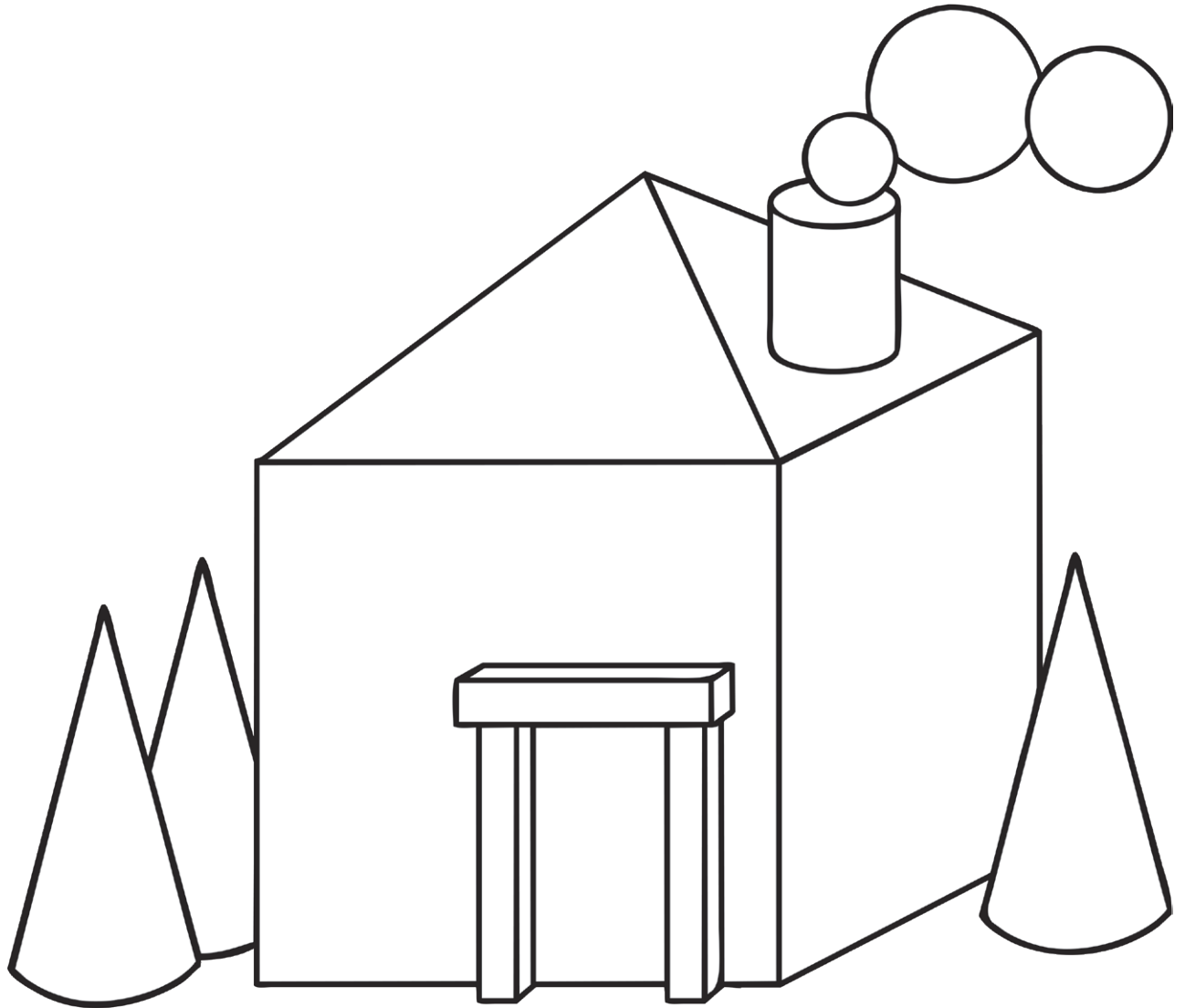

3D Shape Colouring **Answers**

Use the key to colour in the 3D shapes correctly.

Key		
Clues	Name	Colour
no vertices, one curved surface and 2 flat circular faces	cylinder	yellow
8 vertices, 12 edges the same length, 6 faces	cube	orange
5 faces in total (4 faces are triangles and 1 is a square)	square-based pyramid	green
one apex, one circular face	cone	red
8 vertices, 12 edges, 6 faces (2 square, 4 rectangular)	cuboid	purple
no edges, no vertices and one curved surface	sphere	blue

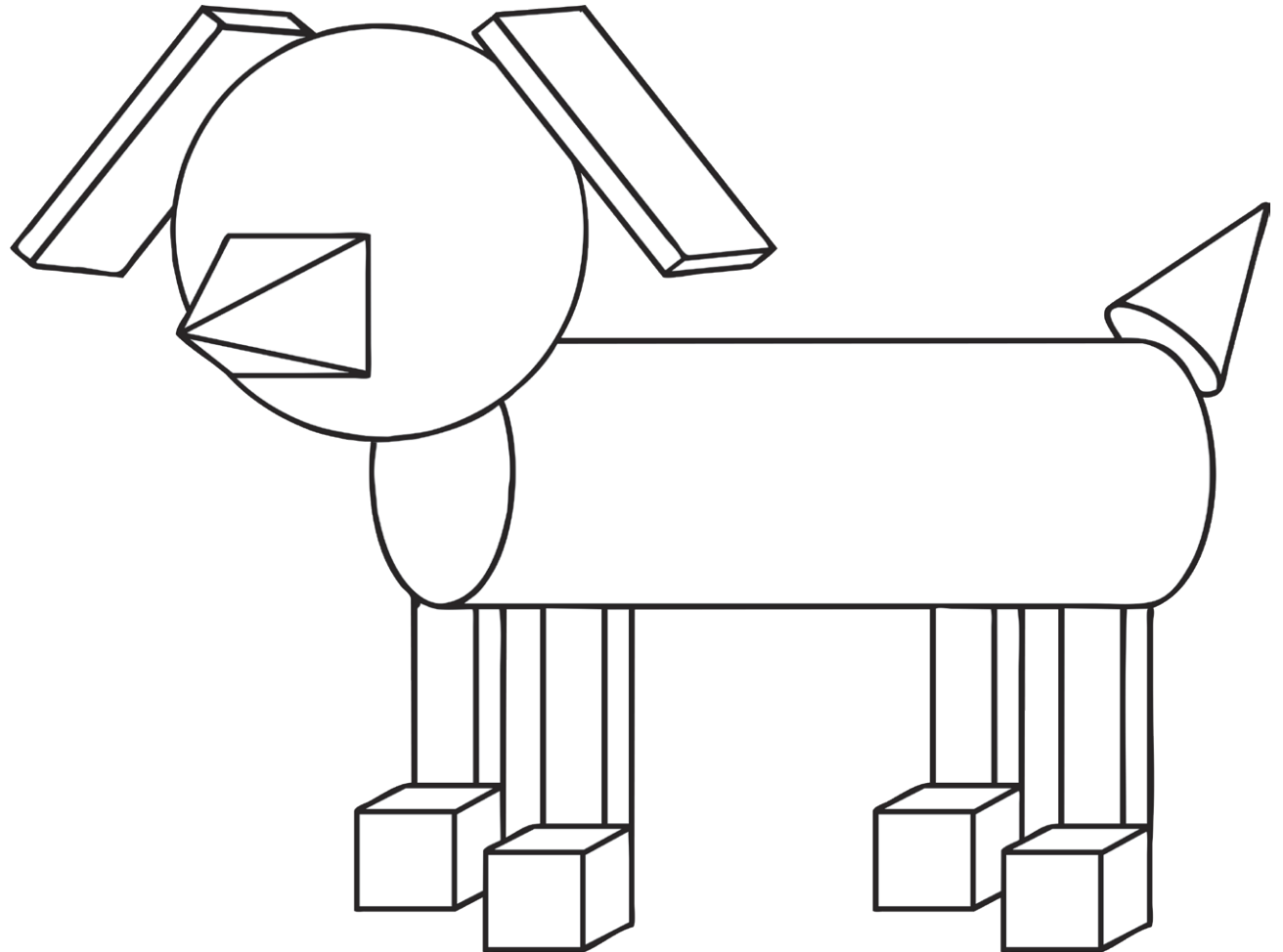

3D Shape Colouring **Answers**

Use the key to colour in the 3D shapes correctly.

Key		
Clues	Name	Colour
no vertices, one curved surface and 2 flat circular faces	cylinder	yellow
8 vertices, 12 edges the same length, 6 faces	cube	orange
5 faces in total (4 faces are triangles and 1 is a square)	square-based pyramid	green
one apex, one circular face	cone	red
8 vertices, 12 edges, 6 faces (2 square, 4 rectangular)	cuboid	purple
no edges, no vertices and one curved surface	sphere	blue

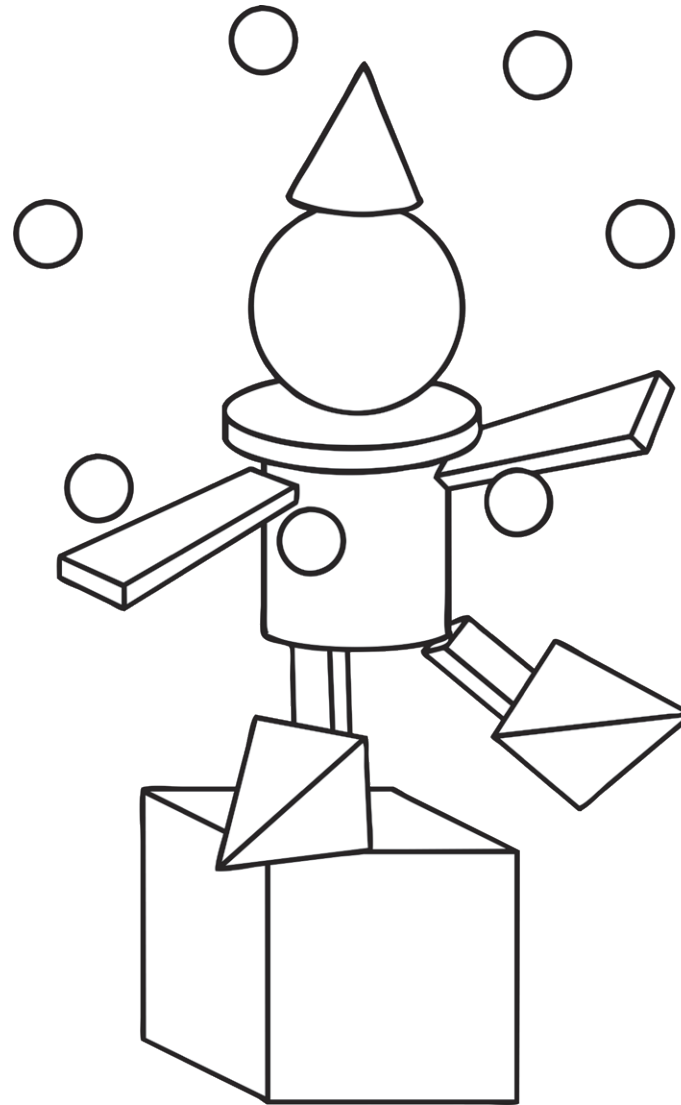

3D Shape Colouring **Answers**

Use the key to colour in the 3D shapes correctly.

Key		
Clues	Name	Colour
no vertices, one curved surface and 2 flat circular faces	cylinder	yellow
8 vertices, 12 edges the same length, 6 faces	cube	orange
5 faces in total (4 faces are triangles and 1 is a square)	square-based pyramid	green
one apex, one circular face	cone	red
8 vertices, 12 edges, 6 faces (2 square, 4 rectangular)	cuboid	purple
no edges, no vertices and one curved surface	sphere	blue

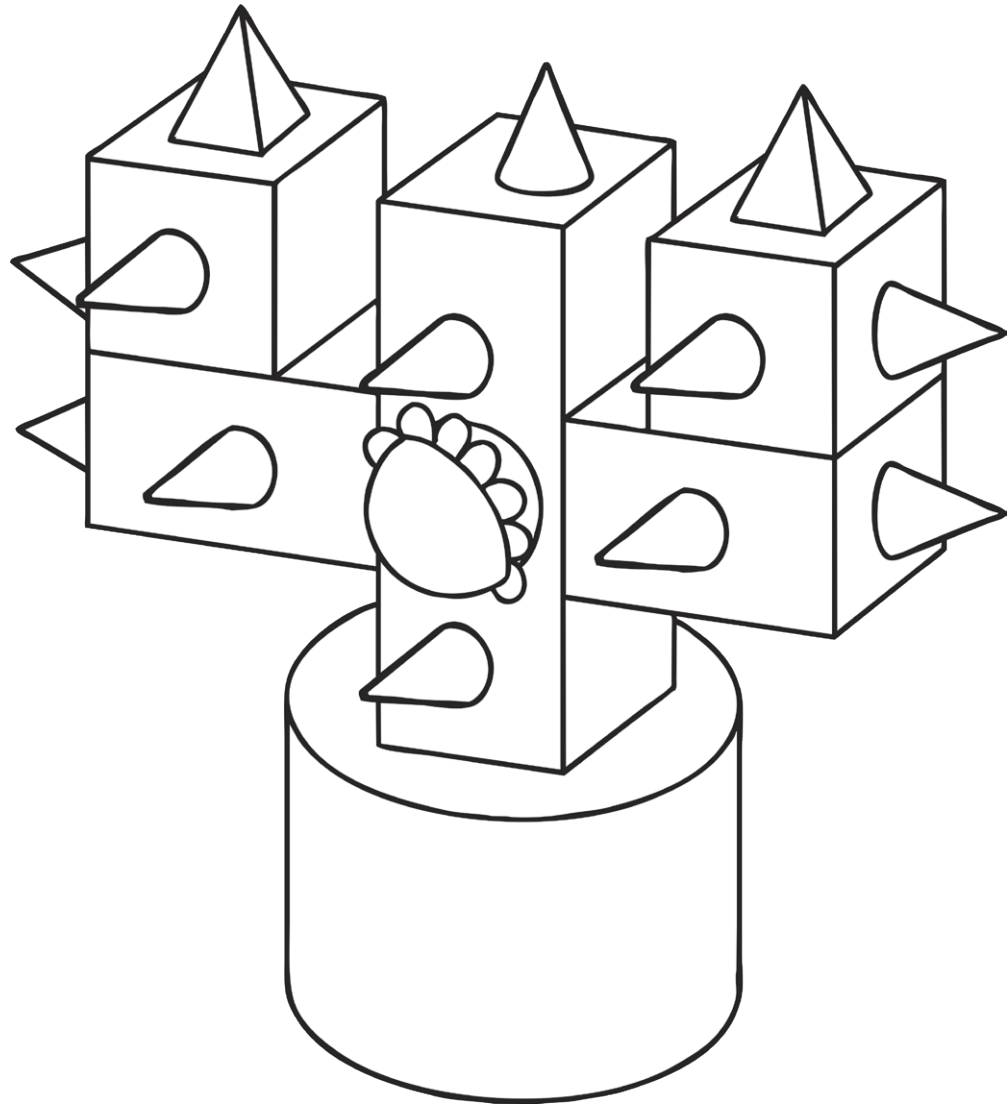

3D Shape Colouring **Answers**

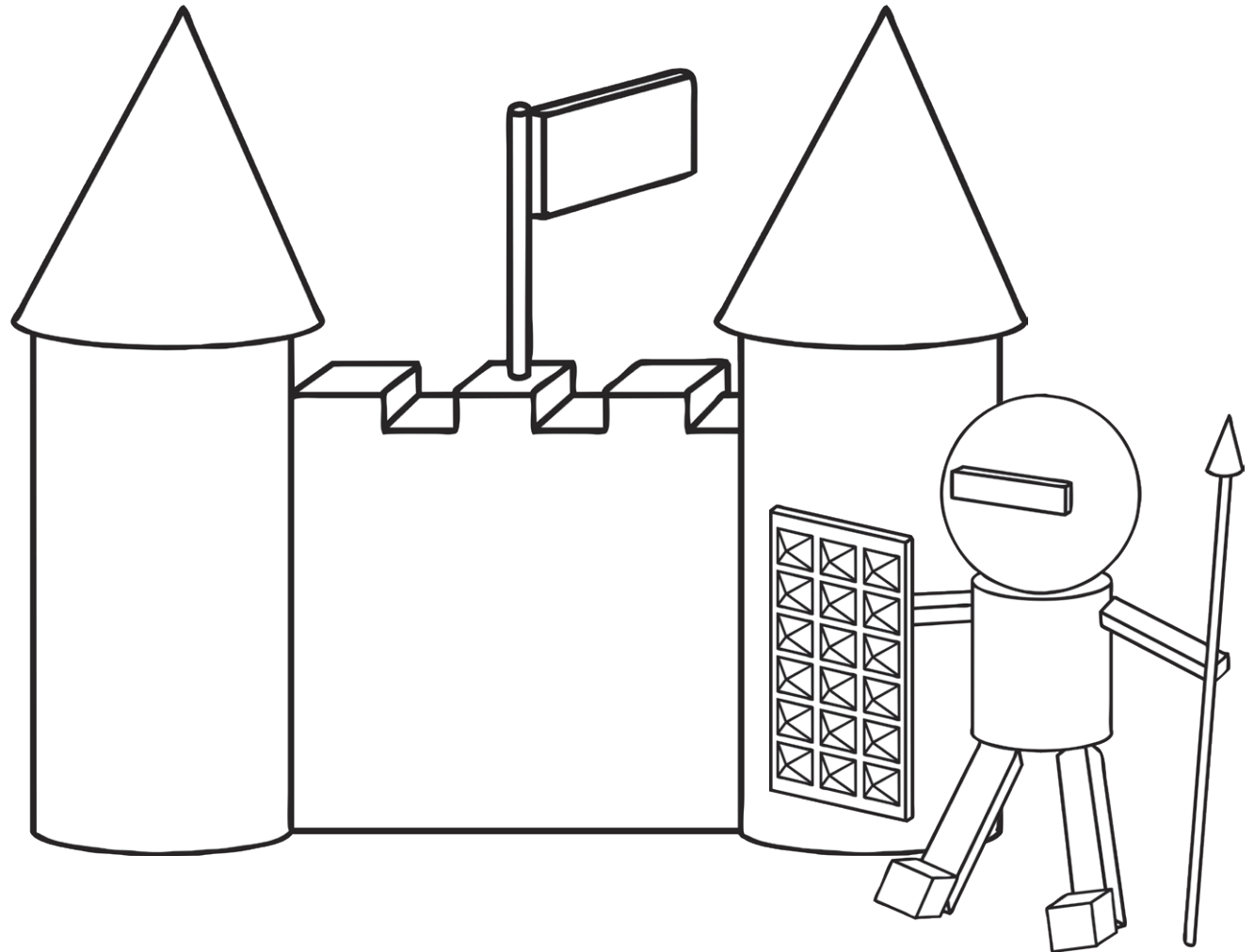

Use the key to colour in the 3D shapes correctly.

Key		
Clues	Name	Colour
no vertices, one curved surface and 2 flat circular faces	cylinder	yellow
8 vertices, 12 edges the same length, 6 faces	cube	orange
5 faces in total (4 faces are triangles and 1 is a square)	square-based pyramid	green
one apex, one circular face	cone	red
8 vertices, 12 edges, 6 faces (2 square, 4 rectangular)	cuboid	purple
no edges, no vertices and one curved surface	sphere	blue



3D Shape Colouring

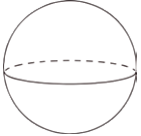
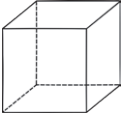
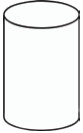
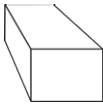
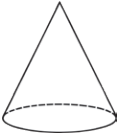

Use the key to colour in the 3D shapes correctly.

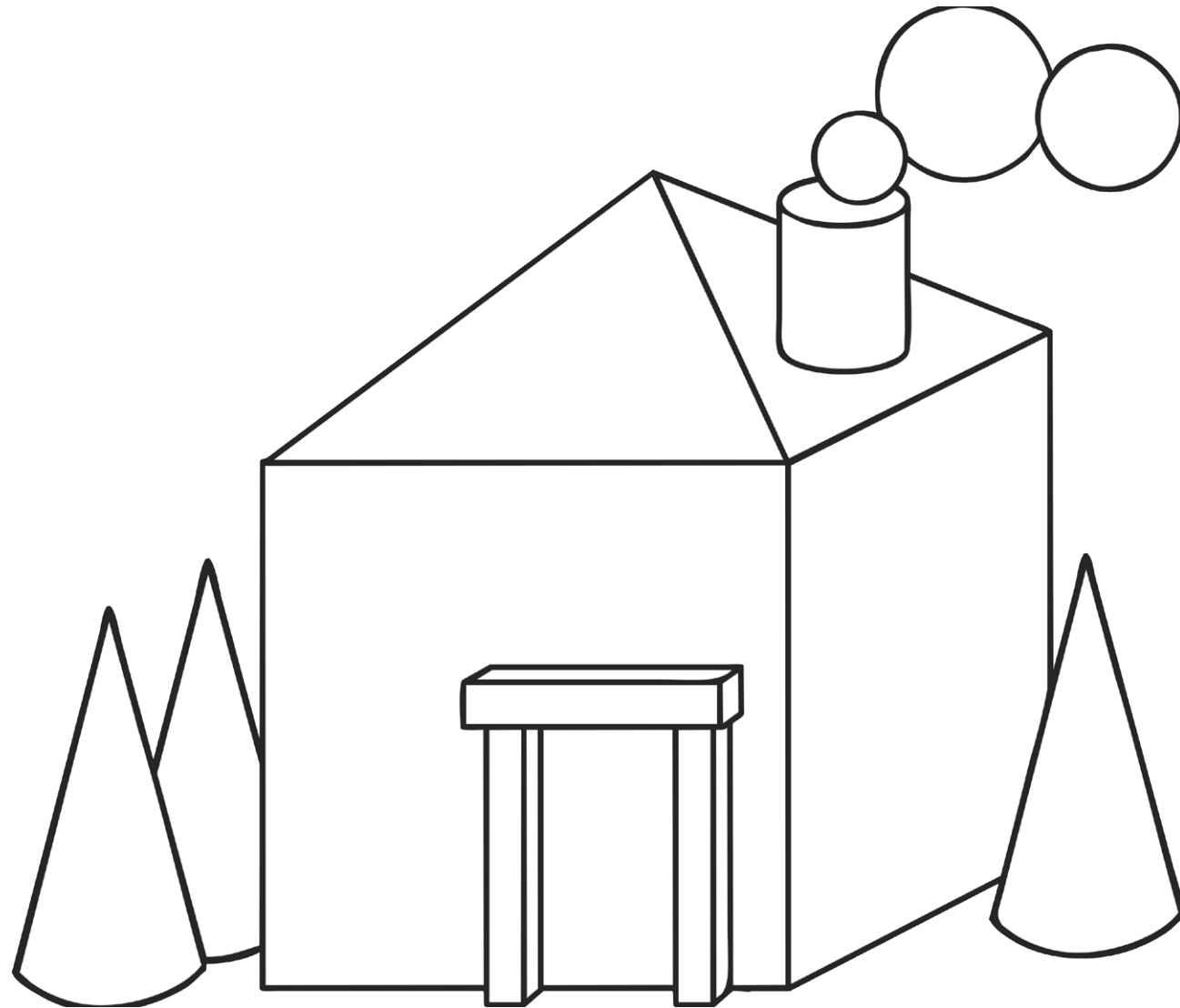
Key	
	red
	blue
	green
	purple
	orange
	yellow



3D Shape Colouring

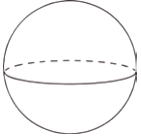
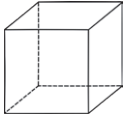
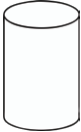
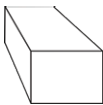
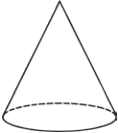

Use the key to colour in the 3D shapes correctly.

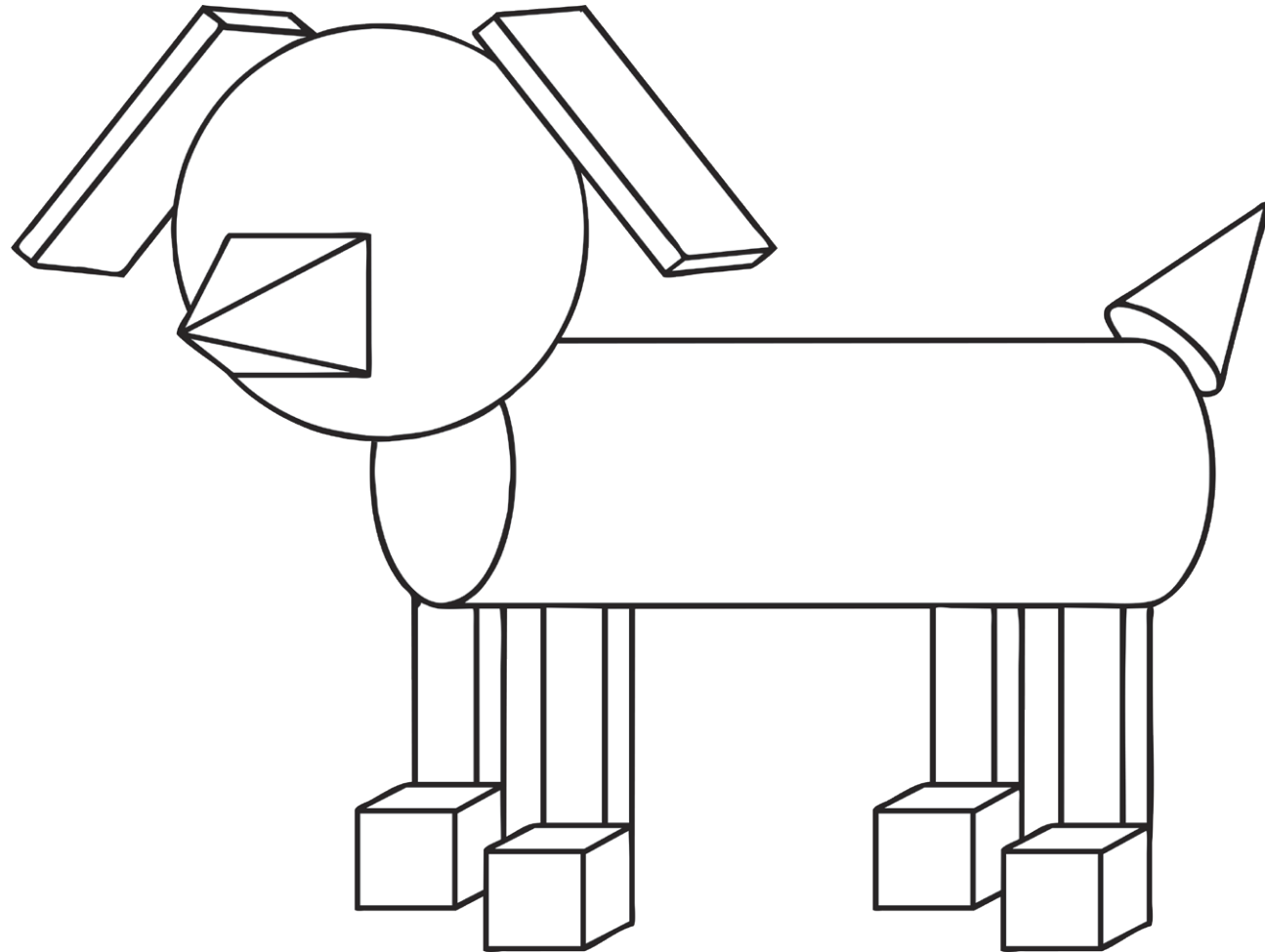
Key	
	red
	blue
	green
	purple
	orange
	yellow



3D Shape Colouring

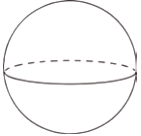
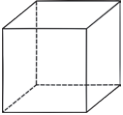
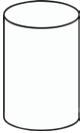
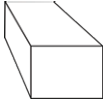
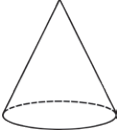

Use the key to colour in the 3D shapes correctly.

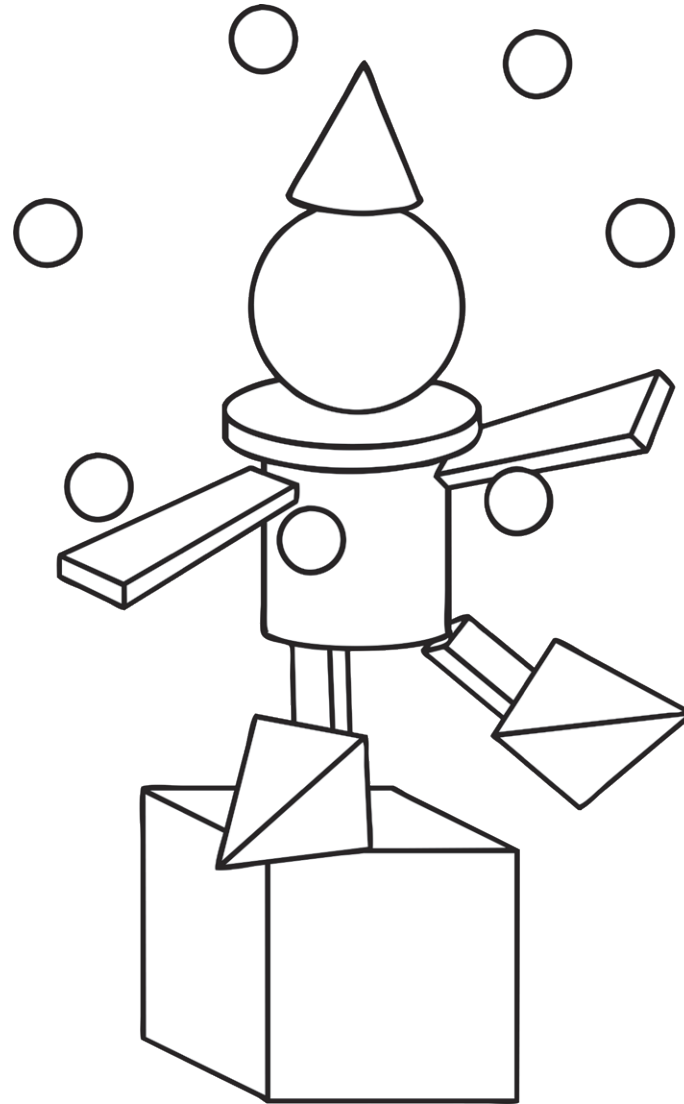
Key	
	red
	blue
	green
	purple
	orange
	yellow



3D Shape Colouring

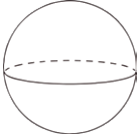
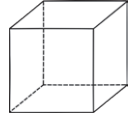
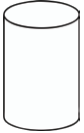
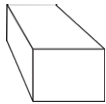
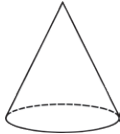

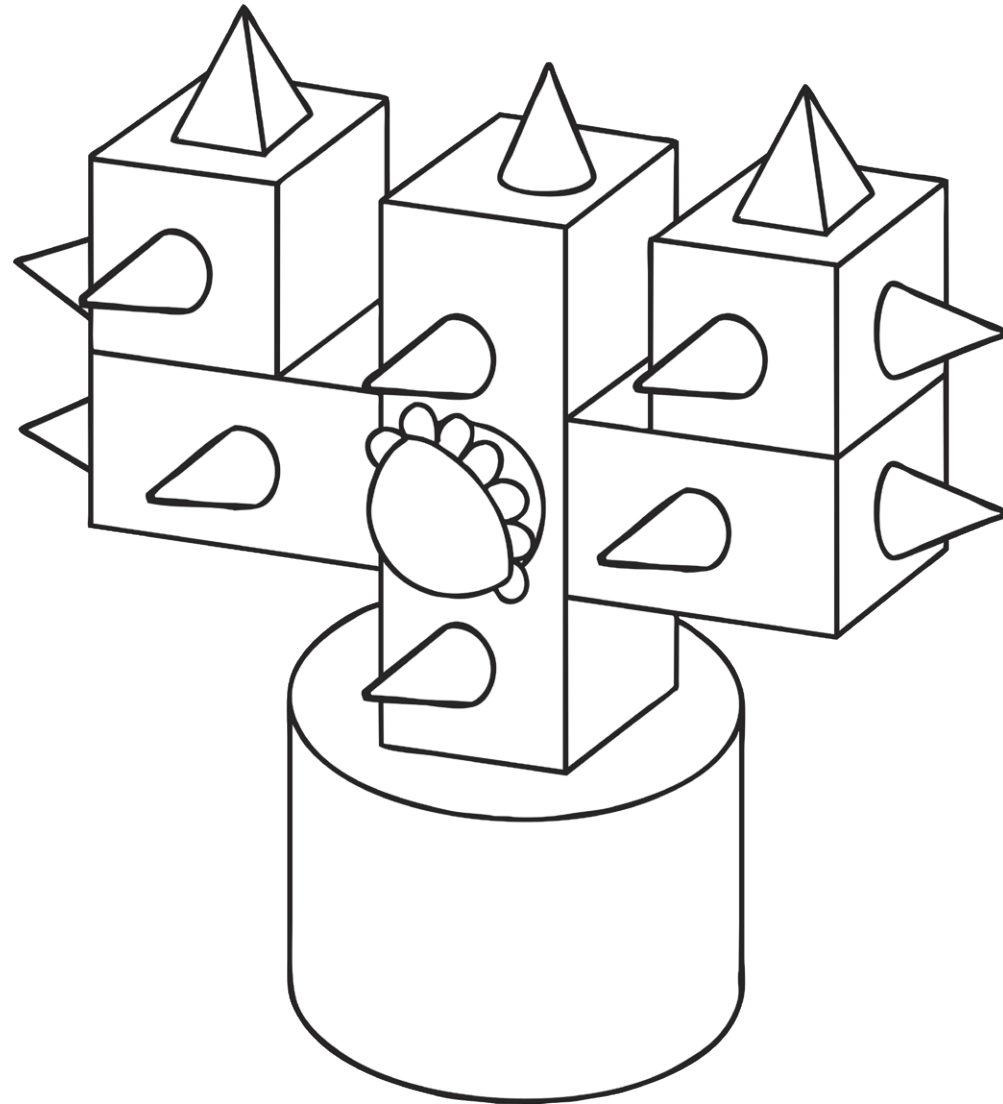

Use the key to colour in the 3D shapes correctly.

Key	
	red
	blue
	green
	purple
	orange
	yellow

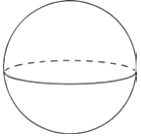
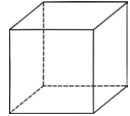

3D Shape Colouring

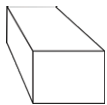
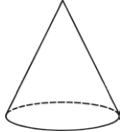

Use the key to colour in the 3D shapes correctly.

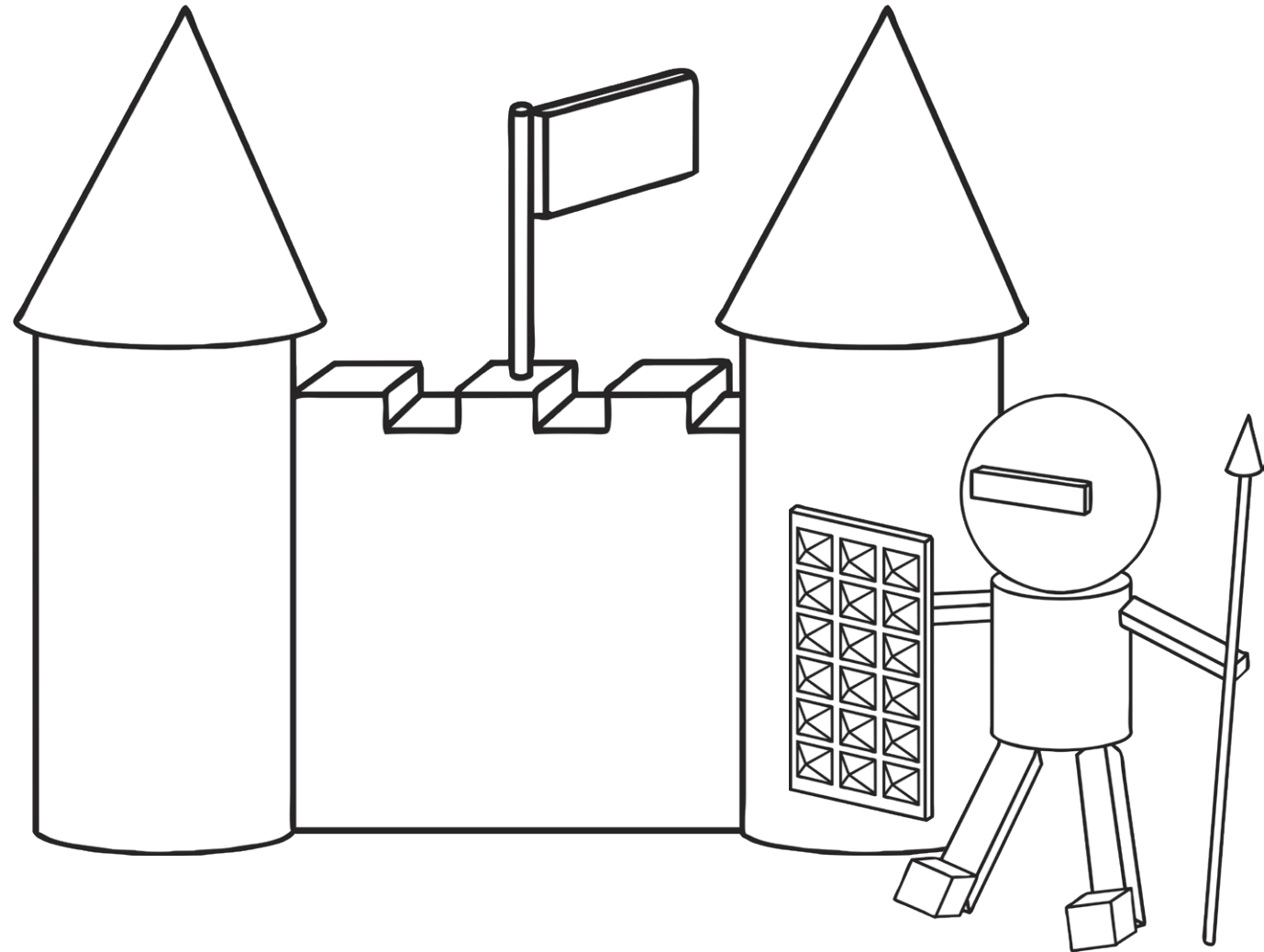
Key	
	red
	blue
	green
	purple
	orange
	yellow



3D Shape Colouring

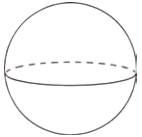
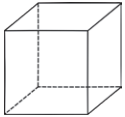
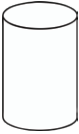
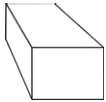
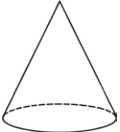

Use the key to colour in the 3D shapes correctly.

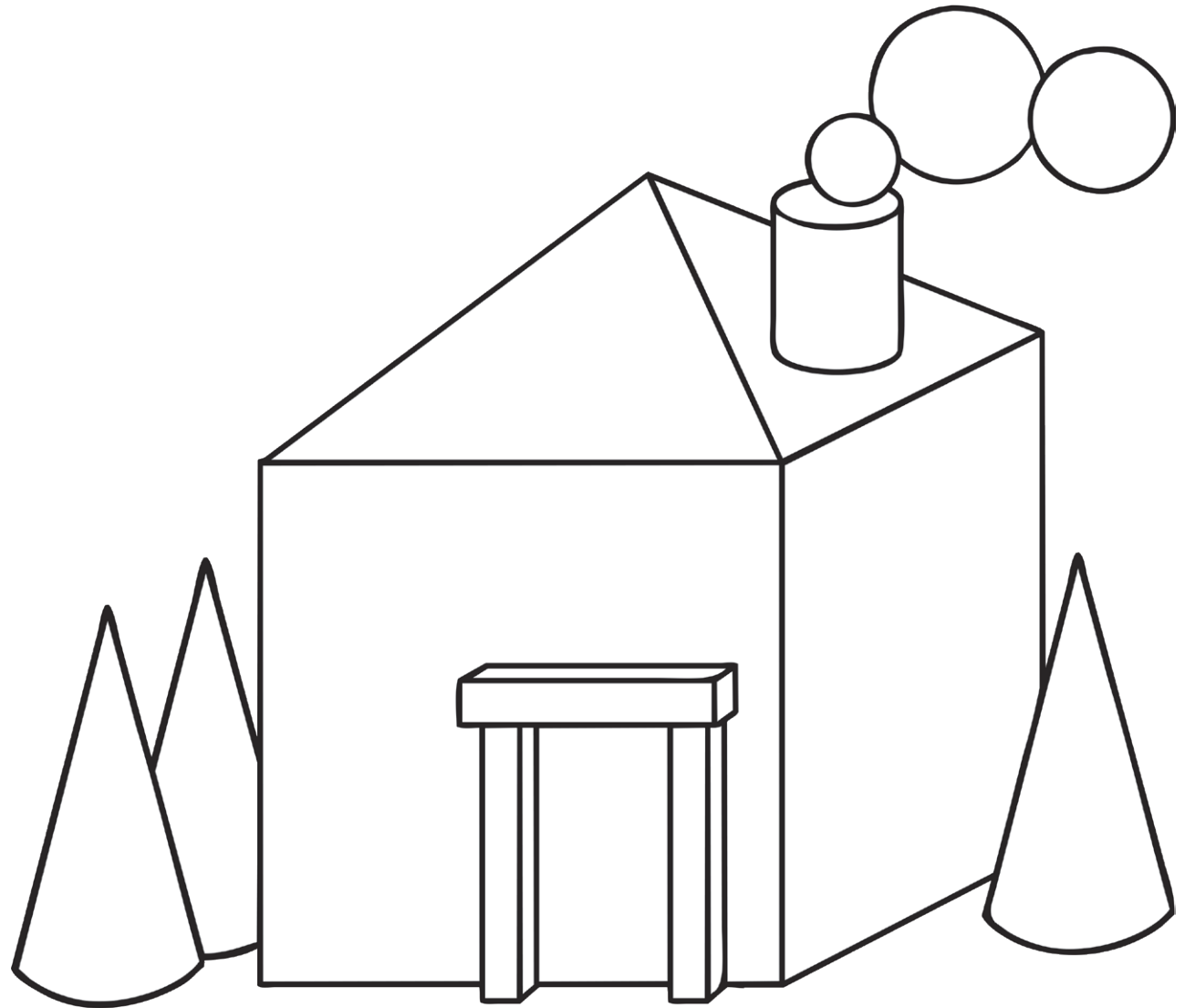
Key		
Shape	Name	Colour
		blue
		yellow
		purple
		green
		orange
		red



3D Shape Colouring

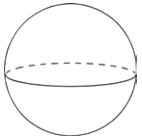
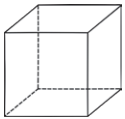
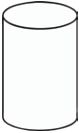
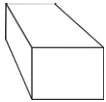
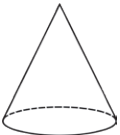

Use the key to colour in the 3D shapes correctly.

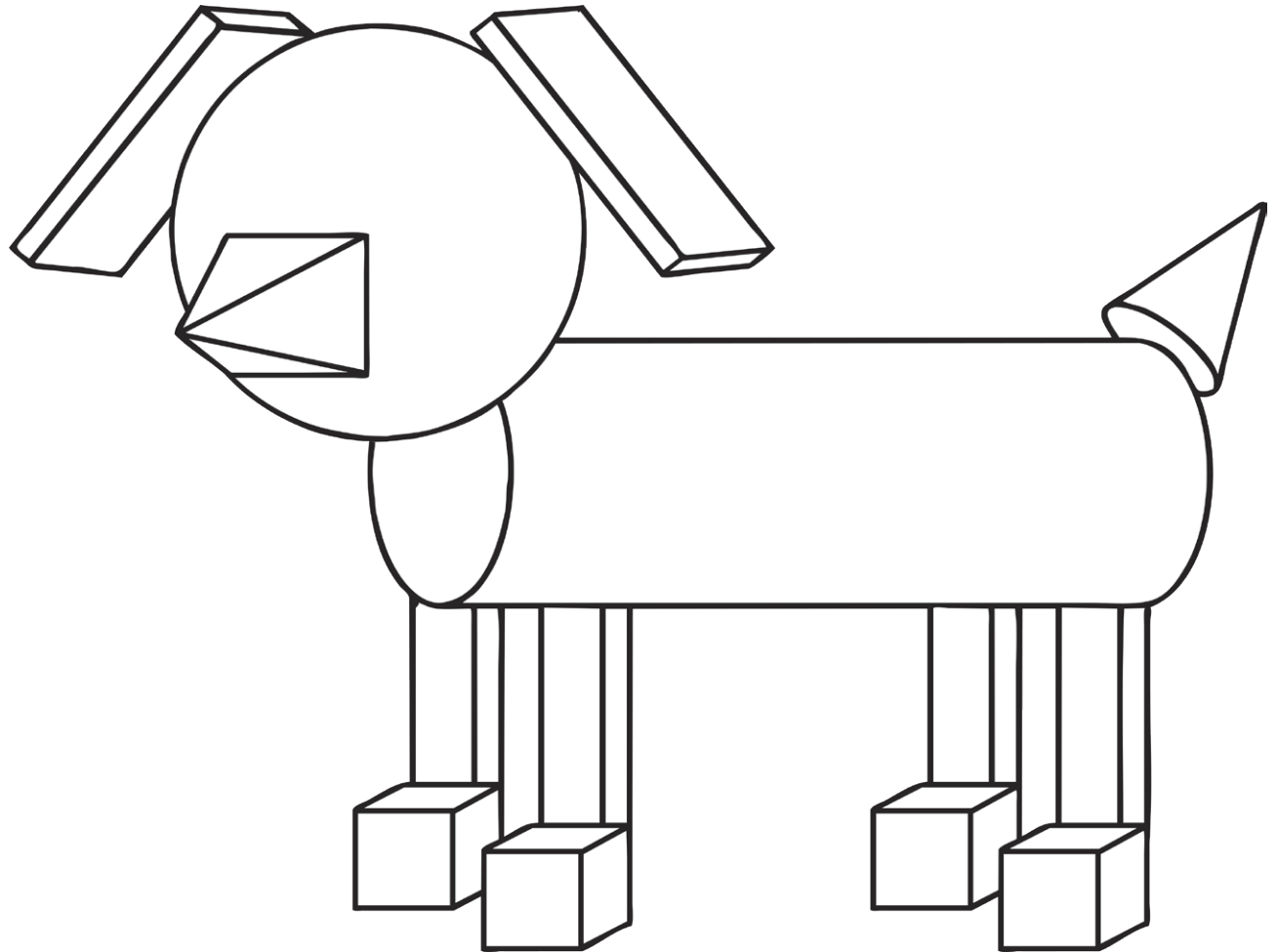
Key		
Shape	Name	Colour
		blue
		yellow
		purple
		green
		orange
		red



3D Shape Colouring

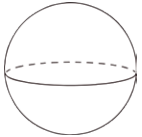
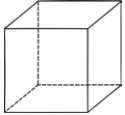
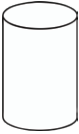
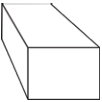
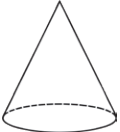

Use the key to colour in the 3D shapes correctly.

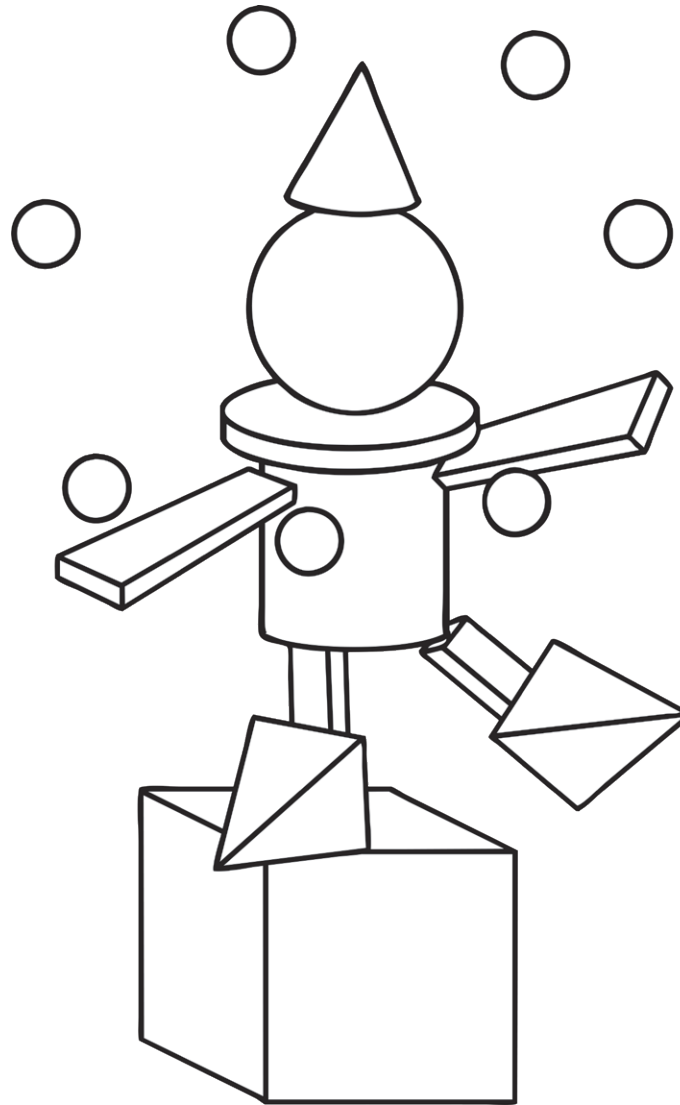
Key		
Shape	Name	Colour
		blue
		yellow
		purple
		green
		orange
		red



3D Shape Colouring

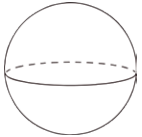
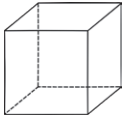
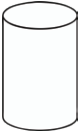
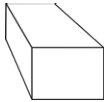
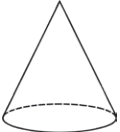

Use the key to colour in the 3D shapes correctly.

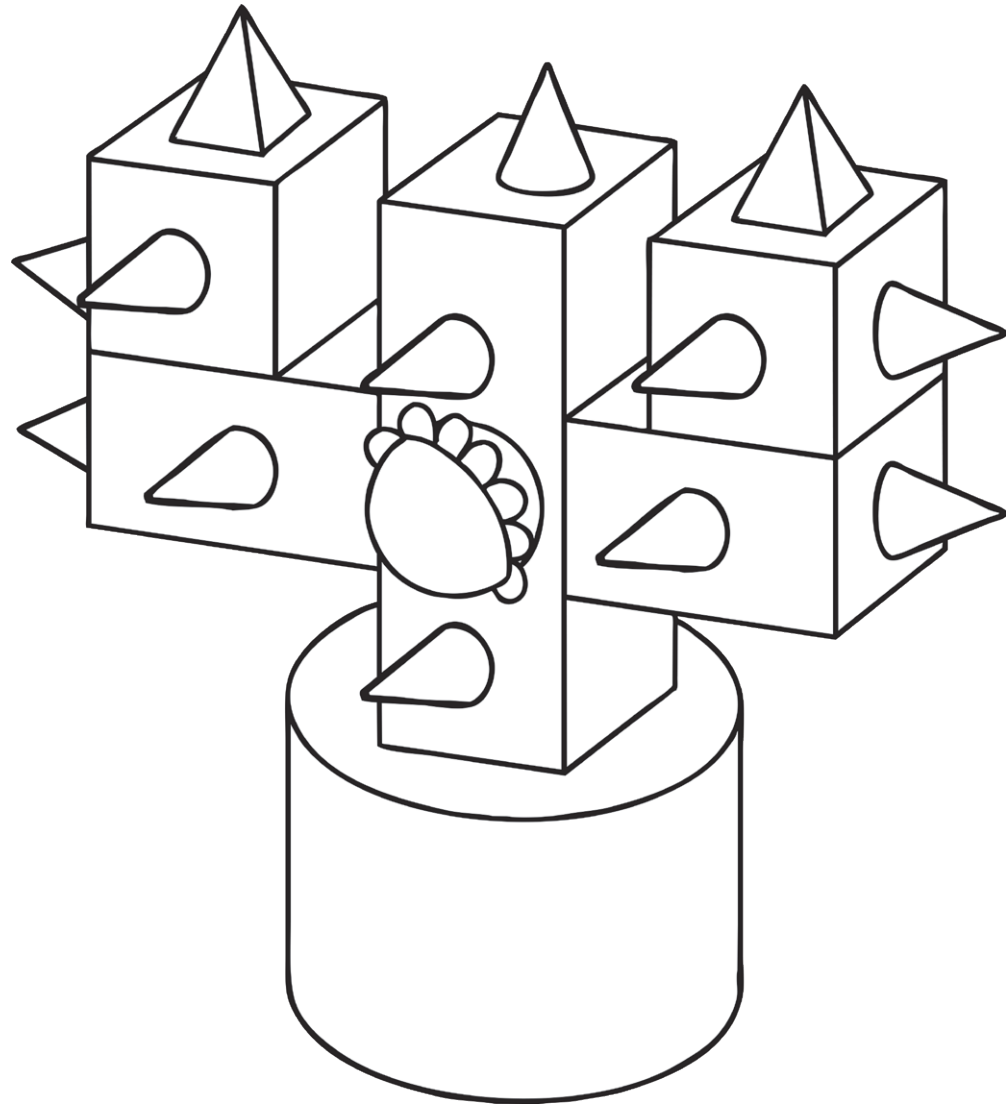
Key		
Shape	Name	Colour
		blue
		yellow
		purple
		green
		orange
		red

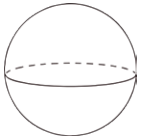
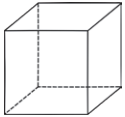
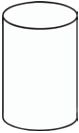
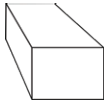
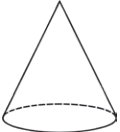

3D Shape Colouring

Use the key to colour in the 3D shapes correctly.

Key		
Shape	Name	Colour
		blue
		yellow
		purple
		green
		orange
		red

